

# CT INVERTER AM CONTROL UNIT

Programmable control board for sliding gates  
with inverter technology



Manual for installation



# 1. Introduction

The Single-phase control unit CT INVERTER AM is a device suitable for operating and controlling the sliding gate in a way easy and complete; it is designed in order to satisfy all possible needs.

The inverter on board allows to set the maximum torque limits along with the possibility to modify the frequency (the speed of the motor).

The possibility to use motors with encoder allows the unit to detect possible obstacles along the run and reverse its direction of motion. It is suitable to command and control automatics accesses with its single-phase motor 230Vac max 1,5KW (current limited to 10A) WITHOUT using a starting condenser. Every control board is equipped with a memory module that stores all personal settings and parameters needed for operating the control board (these data can be transferred from one unit to another one). It is equipped with inputs for self-tested photocells, keys for SS (step-by-step), PED (partial opening), OPEN and CLOSE, switch limits, security stops and a wide display with 3 keys for settings. It is also equipped with a molex connector for a plug-in receiver, output for courtesy and flashing light. It is possible to connect an additional card (R1) to operate an electric lock.

**WARNING: DO NOT INSTALL THE CONTROL UNIT WITHOUT READING THE INSTRUCTIONS FIRST!**

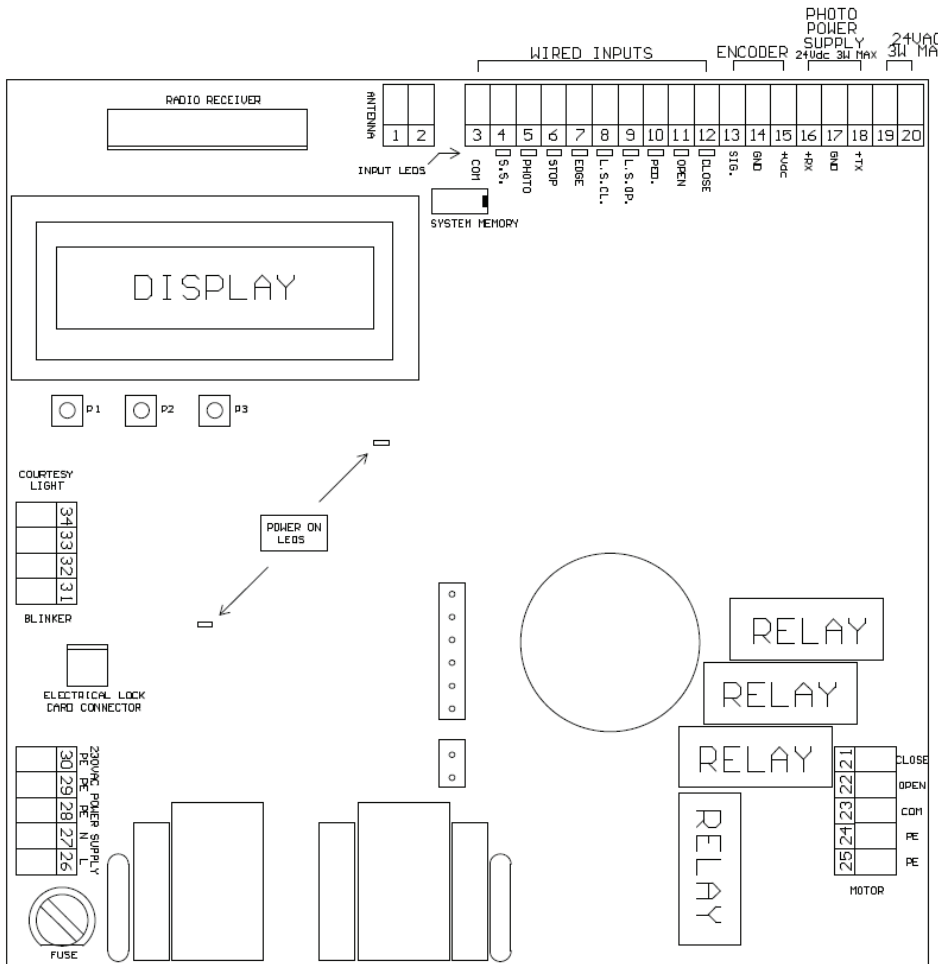

ANTENNA	Antenna
COM	Common
S.S.	Step by Step
PHOTO	Photocell
STOP	Stop
EDGE	Safety edge
L.S.CL.	Closing limit switch
L.S.OP.	Opening limit switch
PED.	Partial opening
OPEN	Opening command
CLOSE	Closing command
ENCODER	Encoder
SIG.	Encoder signal
GND	Ground
PHOTO POWER SUPPLY	Photocells power supply
+RX	Photo Receiver
+TX	Photo transmitter
CLOSE (21)	} Motor connections
OPEN (22)	
COM (23)	
PE	Earth
N	Neutral
L	Phase
SYSTEM MEMORY	System memory
BLINKER	Flashing light
COURTESY LIGHT	Courtesy light
ELECTRIC LOCK CARD CONNECTOR	Electric lock or brake card connector
RADIO RECEIVER	Radio receiver
FUSE	Fuse
INPUT LEADS	Input leds
POWER ON LEADS	Power on leds

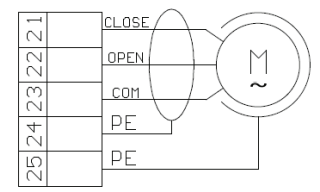
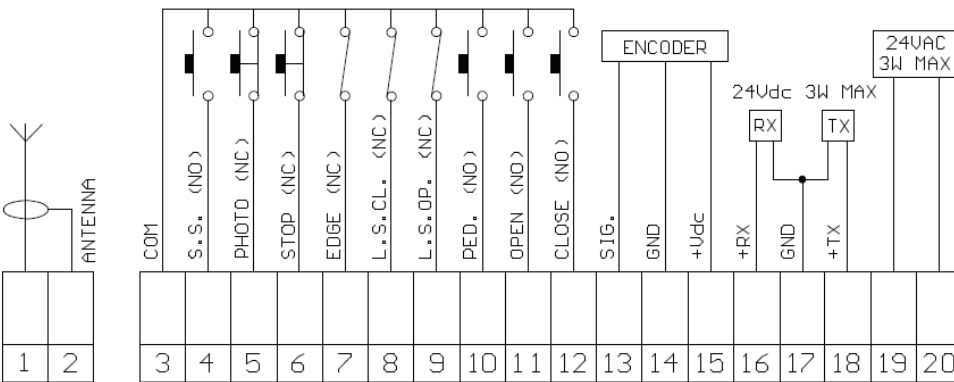

230VAC  
50Hz

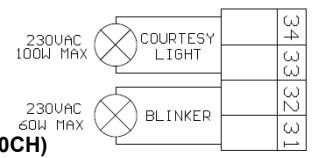
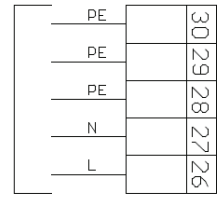

For the connection of the motor we recommend to use a screened cables 3 poles + earth 1.5 mm<sup>2</sup> (type FD781CY)  
For the connection of the possible encoder we recommend to use a screened cable 3 x 0,75mm<sup>2</sup> (type OLFLEX-110CH)

NOTE: All unused NC inputs must be jumpered with the common.

**It is FUNDAMENTAL to connect the motor and the unit to the EARTH in order to operate the control unit correctly!**

**In case an encoder is applied, it is compulsory to use a shielded cable with the screening connected to the EARTH only by one end of the cable itself.**

## 2. Collegamenti

1

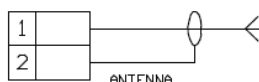

### ANTENNA INPUT

Connect the signal cable of the antenna to the clamp 1 of the terminal board.  
Connect the ground of the antenna to the clamp 2 of the terminal board.

The presence of the metallic parts or humidity in the walls could have negative influences on the range of the system. We suggest therefore to not place the receiving antenna and/or transmitters near big metallic objects, near the floor or on the ground.

2

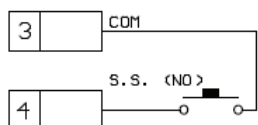

### STEP BY STEP INPUT

Connect the STEP-BY-STEP BUTTON (S.S.) between the clamps 3 and 4.  
**ATTENTION: leave it open if not used**

Under the dead man mode the STEP BY STEP BUTTON operates as OPEN.

3

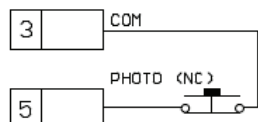

### PHOTOCELL INPUT

Connect the **NORMALLY CLOSED** contact of the photocell (PHOTO) between the clamps 3 and 5 of the terminal board.  
**ATTENTION: jumper the inputs if not used**

The functioning of the photocells can be modified in the MENU A.

4

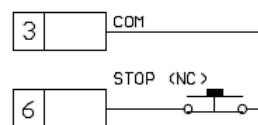

### STOP INPUT

Connect the contact **NORMALLY CLOSED** of the STOP between the clamps 3 and 6 of the terminal board.  
**ATTENTION: jumper the inputs if not used**

5

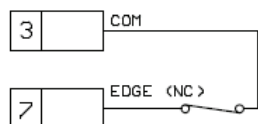

### SAFETY EDGE INPUT

Connect the contact **NORMALLY CLOSED** of the SAFETY EDGE between the clamps 3 and 7 of the terminal board.  
**ATTENTION: jumper the inputs if not used**

6

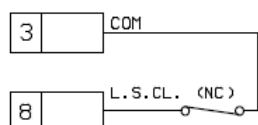

### INPUT CLOSING LIMIT SWITCH

Connect the contact **NORMALLY CLOSED** of the CLOSING LIMIT SWITCH (L.S.CL.) between the clamps 3 and 8 of the control board.

Before activating the installation make sure that the limit switches are functioning and correctly cabled.

7

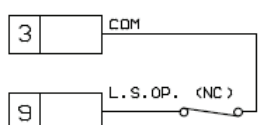

### INPUT OPENING LIMIT SWITCH

Connect the contact **NORMALLY CLOSED** of the OPENING LIMIT SWITCH (L.S.CL.) between the clamps 3 and 9 of the terminal board.

Before activating the installation make sure that the limit switches are functioning and correctly cabled.

8

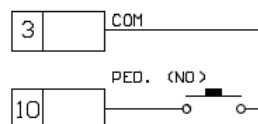

### PARTIAL OPENING INPUT

Connect the PARTIAL OPENING button (PED.) between the clamps 3 and 10 of the terminal board.  
**ATTENTION: leave it open if not used**

Under the dead man mode the PARTIAL OPENING button operates as CLOSE.

9

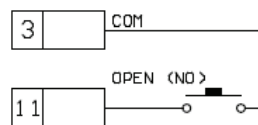

### OPEN INPUT

Connect the button OPEN between the clamps 3 and 11 of the terminal board.  
**ATTENTION: leave it open if not used**

10

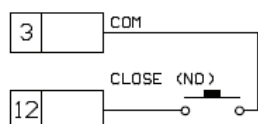

### CLOSE INPUT

Connect the button CLOSE between the clamps 3 and 12 of the terminal board.  
**ATTENTION: leave it open if not used**

11

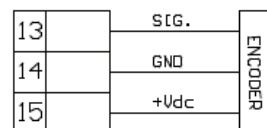

### ENCODER INPUT

Connect the SIGNAL cable of the encoder to the clamp 13 of the terminal board.  
Connect the GND cable of the encoder to the clamp 14 of the terminal board.  
Connect the cable +Vdc of the encoder to the clamp 15 of the terminal board.  
**ATTENTION: leave it open if not used**

The activation/desactivation of the encoder function is controlled in the MENU A

**For the connection of the possible encoder we recommend to use a screened cable 3 x 0,75mm<sup>2</sup> (type OLFLEX-110CH)**

12

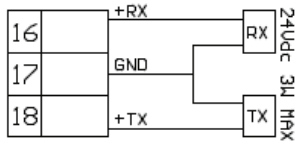

**PHOTOCELLS POWER SUPPLY**

Connect the **clamp 16** of the control unit to the **clamp +** of the power supply of the photocells receiver.  
 Connect the **clamp 17** of the control unit to the power supply **clamp -** of the photocells receiver and of the transmitter.  
 Connect the **clamp 18** of the control unit to the power supply **clamp** of the transmitter of the photocells.

The photocells test test is activated by the MENU A. **ATTENTION:** the control unit gives a voltage of 24 Vdc and can supply a maximum power of 3W.

For the safety edges test connect the test device of the safety edge on the power supply pins of the TX (test activated with low logic signal 0Vdc). Please refer to the manual of the safety edge.

13

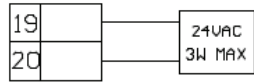

**ACCESSORIES OUTPUTS**

Accessories output 24Vdc 3W.

14

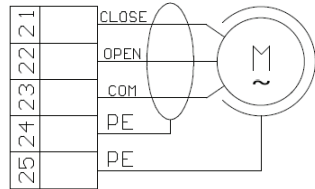

**MOTOR OUTPUT**

Connect the **common** of the motor to the clamp 23 of the control unit.  
 Connect the **open** of the motor to the clamp 22 of the control unit.  
 Connect **close** of the motor to the clamp 21 of the control unit.

Before activating the automation make sure that all the safety devices are correctly cabled and functioning, refer to the preliminary checkings section of chap.4

Cable the motor WITHOUT using the capacitor.

**For the connection of the motor we recommend to use a screened cables 3 poles + earth 1.5 mm<sup>2</sup> (type FD781CY)**

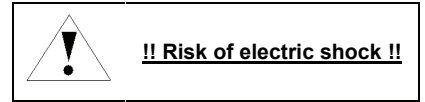

15



**POWER SUPPLY**

Connect the power supply cable to the clamps 26 and 27, connect the ground to one of the clamps PE 28, 29 or 30.

Do not connect the card directly to the electric network. Put a device which can ensure the disconnection of each pole from the power supply of the control unit  
 Use a cable with correct section according to the current absorbed by the motor.

16

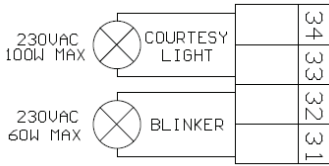

**COURTESY LIGHT**

Connect the courtesy light to the clamps 33 and 34, 230Vac 100W MAX.

It is possible to light up the action area of the automatism during each motion.  
 The functioning of the auxiliary light is controlled by the MENU A.

**FLASHING LIGHT**

Connect the flashing light to the clamps 31 and 32.

Use a flashing light without self flashing card 230Vac 60W MAX

**LANGUAGE SETTING**



**It is suggested to select the language before any other operations**

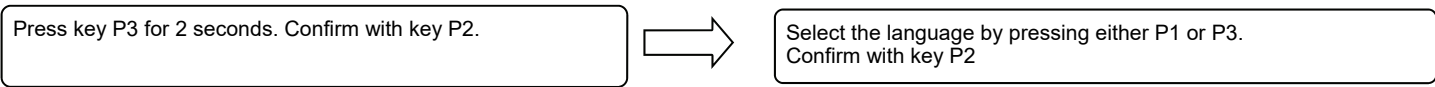

**3 Programming Menu**

This procedure must be carried out **ONLY** by the installer and **ONLY** during the installation of the system.  
**WARNING:** the motor must be still, preferably in closed position, in order to access the programming menu!

**3.1 Activation and selection of the programming menu**

The control unit CT INVERTER AM is equipped with **THREE** user menus (**MENU A, MENU B, MENU C**), by which it is possible to regulate, program and modify all functional parameters. Follow the indications on the display during the programming phases.

- MENU A** - allows to activate the optional functions and to select the intervention modalities of the security systems.
- MENU B** - it is dedicated to the learning of the runs, to the operations related to the manual movement and to the regulation of the control parameters of the motor
- MENU C** - menu for auxiliary configurations for user's support



**Some parts of the control unit are subject to dangerous voltages!**  
**Pay attention during the phase of manual accessing to the control board**

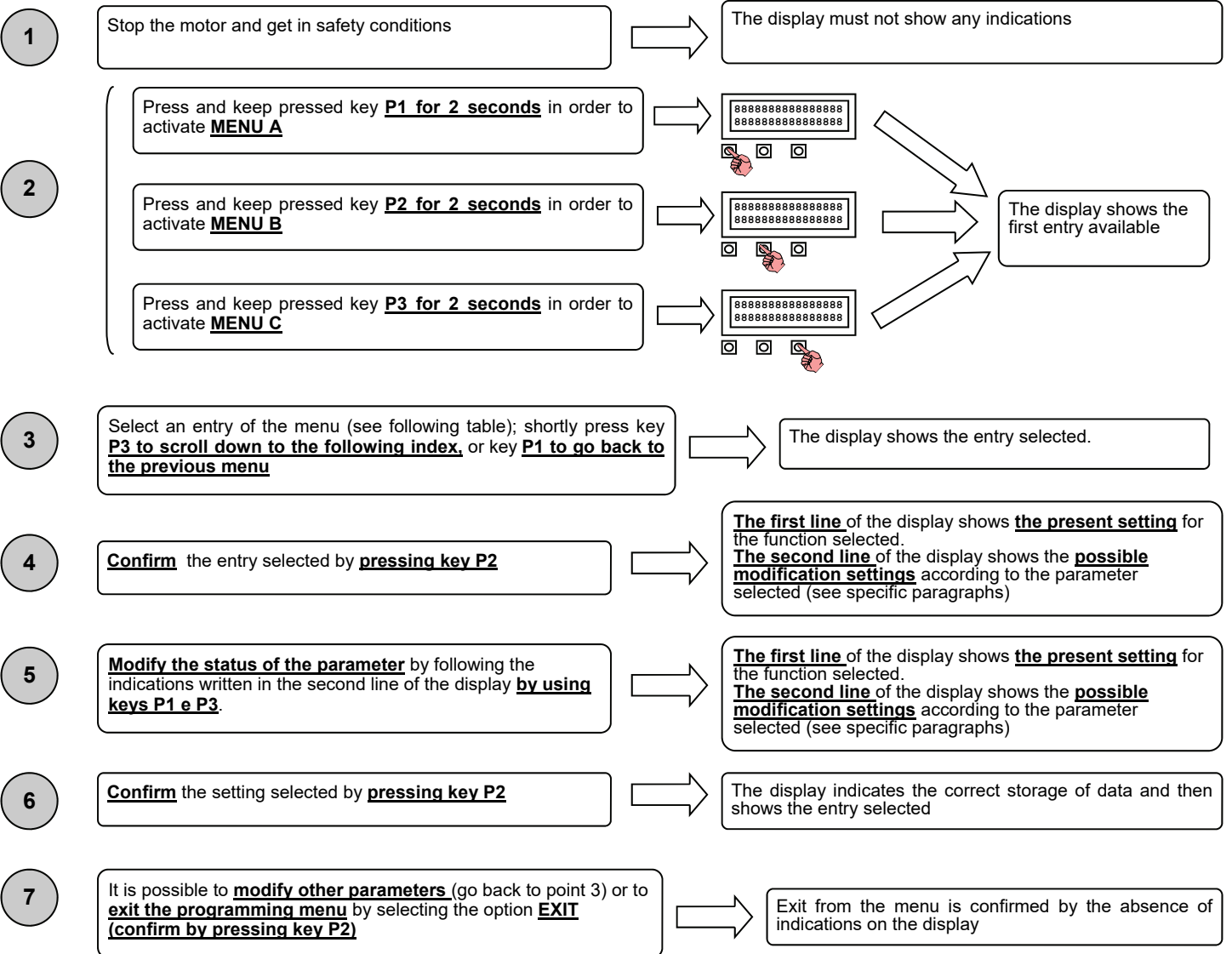

AUTOMATIC EXIT FROM THE MENU: the menu exits automatically in case of long inactivity (longer than 15 seconds)



### 3.2 Programming menu A (key P1)- List of parameters

The following table lists the entries of menu A and reports a short description of the parameters that can be adjusted; refer to paragraph ADVANCED FUNCTIONS for more details

MENU A	Auto ReclosingTim	Timed closure of the gate (only from total or partial opening) <i>OFF</i> : disabled <i>HH:MM:SS</i> : time of persistence in opening position
	PhotoAuto Reclose	Immediate closing after the intervention of the photocell (only from total or partial opening) <i>OFF</i> : disabled <i>ON</i> : the gate closes 3 seconds after the contact between photocell has restored
	Brake	Brake operation (for motors with high inertia). <i>OFF</i> : disabled 1: electronic brake 2: activation of the contact on the auxiliary card for an external brake, active with still motor 3: activation of the contact on the auxiliary card for an external brake, active when motor is moving
	Dead Man	"Dead Man" mode. The motor moves only by means of a permanent command <i>OFF</i> : disabled <i>ON</i> : enabled (WARNING: automatic motions are disabled)
	Condominium	Condominium function. The commands <i>S.S.</i> and <i>PED</i> allow only the opening of the gate <i>OFF</i> : disabled <i>ON</i> : enabled (WARNING: enable the "Automatic Re-Closure" in order to close)
	Photo Inv	Photocell intervention modality <i>OFF</i> : the gate stays still until the obstacle is removed, and then opens completely <i>ON</i> : the gate opens completely (this function does not apply in opening)
	Photo Test	Functional test of the photocell; it is executed before the gate moves <i>OFF</i> : disabled <i>ON</i> : test activated (WARNING: supply the photocell with power as shown in the scheme)
	Edge Inv	Modality of operation of the safety edge (sensible edge) <i>OFF</i> : the gate stops <i>ON</i> : the gate opens completely (this function does not apply in opening)
	Edge Test	Functional test of the safety edge; it is executed before the gate moves <i>OFF</i> : disabled <i>ON</i> : test activated (WARNING: supply the safety edge with power as specified in the chap. 2.12)
	Pre-Blink	Short flash before the motion of the gate <i>OFF</i> : disabled <i>ON</i> : enabled
	Area light	Modality of functioning of the auxiliary output for lighting <i>OFF</i> : courtesy light <i>ON</i> : zone light (lit-off only when the gate is completely closed)
	Aux Light Time	Auxiliary light's switching-off delay for lighting <i>OFF</i> : Auxiliary light's output disabled <i>HH:MM:SS</i> : switching-off delay - auxiliary light's output enabled
	Clock	Programmed opening function <i>OFF</i> : disabled <i>ON</i> : the gate opens and stays open until the OPEN input is active
	Water Hammer OP	Water hammer before the gate opens <i>OFF</i> : disabled <i>XX,Xs</i> : enabled. Adjustment of pressure time (in seconds) applied to the mechanical stop in closing
	Encoder	Functioning with encoder (only for motors equipped with a suitable encoder) <i>OFF</i> : disabled <i>ON</i> : enabled (WARNING: the re-programming of the runs is needed)
	Sensor level	Level of operation of the "motor still sensor" (with active encoder only) <i>OFF</i> : sensor disabled <i>NNN</i> : sensor enabled - adjustment of operation's sensitivity
Sensor Inv	Modality of operation of the "motor still sensor" (with active encoder only) <i>OFF</i> : the gate stops <i>ON</i> : reverses shortly in opening; opens completely in closing	
EXIT		

### 3.3 Programming menu B (key P2) - List of parameters

The following table lists the entries of menu A and reports a short description of the parameters that can be adjusted; refer to paragraphs dedicated to each function for more information

MENU B	Manual Motion	Allows to move the gate at low speed by using the keys located on the control board. This function is fundamental in order to check the motion during the installation
	End position	Learning the full run of the gate, both in opening and in closing WARNING: this operation must start when the gate is completely closed
	Ped. Position	Learning of the opening partial run WARNING: this operation must start when the gate is completely closed
	High Speed OP	Regulation of the normal speed of the gate during the opening phase NNN: speed expressed in Hz (frequency of the wave supplied to the motor)
	Low Speed OP	Regulation of the speed of the gate during the opening phase when approaching the end of the run NNN: speed expressed in Hz (frequency of the wave supplied to the motor)
	High Speed CL	Regulation of the normal speed of the gate during the closing phase NNN: speed expressed in Hz (frequency of the wave supplied to the motor)
	Low Speed CL	Regulation of the speed of the gate during the closing phase when approaching the end of the run NNN: speed expressed in Hz (frequency of the wave supplied to the motor)
	High Torque OP	Torque supplied to the motor during the opening phase at normal speed NNN: percentage of torque supplied to the motor
	Low Torque OP	Torque supplied to the motor during the opening phase when approaching the end of the run NNN: percentage of torque supplied to the motor
	High Torque CL	Torque supplied to the motor during the closing phase at normal speed NNN: percentage of torque supplied to the motor
	Low Torque CL	Torque supplied to the motor during the closing phase when approaching the end of the run NNN: percentage of torque supplied to the motor
	EXIT	

### 3.4 Programming menu C (key P3) - List of parameters

The following table lists the entries of menu A and reports a short description of the parameters that can be adjusted; refer to paragraphs dedicated to each function for more information

MENU C	Language	Select the language (where applicable)
	Backlight	Backlighting of the display OFF: the light of the display is disabled ON: the light of the display is enabled and its automatic switching-off is timed (Energy saving)
	Reset	Total reset of factory settings of the control board. WARNING: all programming operations and the setting of the control board must be repeated after this operation
	EXIT	

## 4. Preliminary checks

The preliminary checks must be carried out only by professionals and by paying maximum attention. The correct wiring of the motor and the limit switches is very important for the correct functioning of the automation.

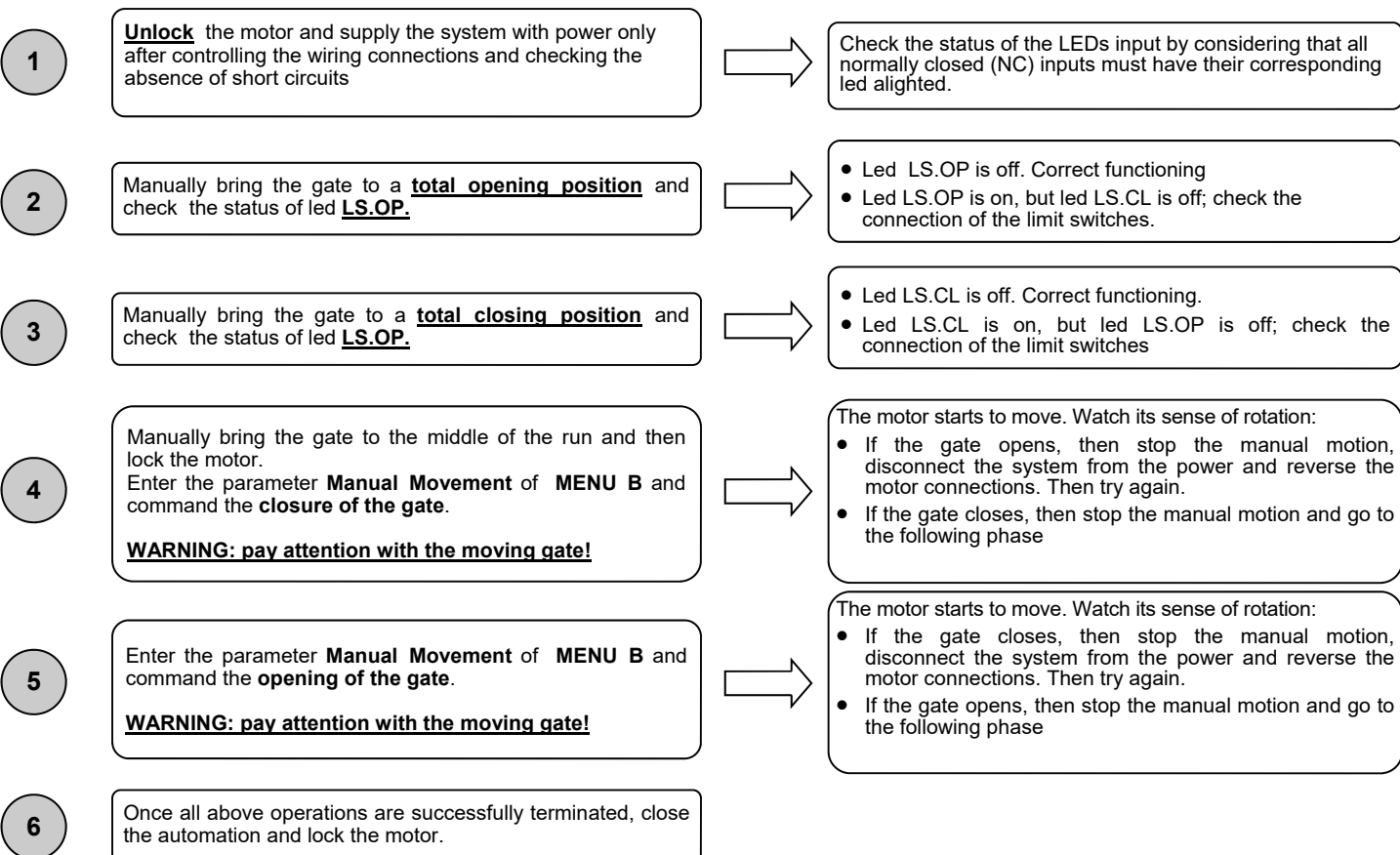

## 5. Manual motion (Menu B - Manual movement)

This operation must be carried-out only by qualified personnel and by paying maximum attention.

The manual motion is an operation planned only for the phase of installation; it allows to move the gate at a limited speed in both directions.  
**WARNING:** the photocells and the safety edge are not monitored during this phase!



## 6. Learning

### 6.1 Learning the run of the gate (Menu B - Final position)

Learning the run allows to define the parameters of the run of the gate, such as the width of the run at normal speed and at slowed speed. Check that the adjustment of the torque and the speed of the gate are set before carrying out the learning phase. Check that the gate is closed before starting the learning phase.

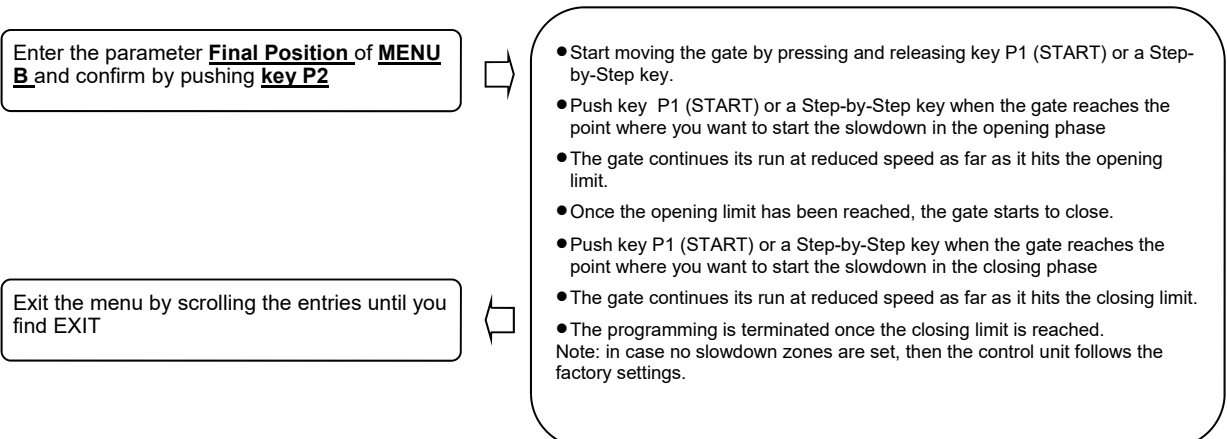



## 6.2 Learning the partial run (Menu B – Ped. Position)

Learning the partial run allows to define the position of partial opening that allows the pedestrians accessing (PED command)  
Check that the adjustment of the torque and the speed of the gate are set before carrying out the learning phase.  
Check that the gate is closed before starting the learning phase.

Enter the parameter **Ped. Position** of **MENU B** and confirm by pressing **key P2**



Start moving the gate by pressing and releasing key P1 (START) or a Step-by-Step key.  
When the gate reaches the position of partial opening, then push key P1 (START) or a step-by-step key  
The gate moves again in closing.  
When the gate hits the limit in closing, then the programming is terminated.

Exit the menu by scrolling the entries until you find EXIT



## 7 Adjustment of the speed and the torque (Menu B - Speed and torque)

The entries of menu B - Speed and torque - once the parameters themselves are entered allow to adjust the corresponding parameters from a minimum up to a maximum value, according to the indications shown on the display.  
The versatility of the control board allows an infinity of possible combinations: however it is recommended to adjust the settings by keeping into account the dimensions and weight of the gate. High speeds may be dangerous, as well as high torques.  
Such regulations must be carried out only by professionals.  
It is recommended to check the correct functioning of the automation after any regulation.  
It is highly recommended to learn the runs of the gate each time these parameters are changed.

## 8. Advanced functions

These are functions and/or functional modalities that can be activated by the user through the programming menu.

### Automatic closing

Timed closing of the gate from totally open position or partial opening position. The “stop” command disables the automatic closing until a new command given by the user is received (S.S., CLOSE, etc).

### PhotoAutoReclose

The gate closes 3 seconds after the photocell intervenes in case the gate is in a totally open or in a partial open position.

### Motor brake

To be used with motors with a strong inertia and the necessity to quickly stop the automation. Pay attention as the mechanics must be sized accordingly.

OFF: Brake disabled

1: Electronic braking function

2: Activation of the contact on the auxiliary card for an external brake, active with still motor

3: Activation of the contact on the auxiliary card for an external brake, active when motor is moving

### Dead Man

The motor moves only with permanent a command and not with just impulses: the motor opens if the key “open” is kept pressed, and the opposite operation applies with the key “close”. WARNING: this modality forbids all operations of automatic motion!

### Condominium

All commands given via radio or by a step-by-step and/or a partial opening keys involve only the opening of the gate. The closing is related to the function of automatic closing, which **MUST BE ABSOLUTELY ACTIVATED**, since every command of closing is ignored.

### Inv. On photocells

Allows to set if, once the photocell beam is interrupted, the gate must reverse immediately (only in closing) or just after the removal of the obstacle (it applies both in opening and in closing)

### Photocell test

This control unit is equipped with a function which allows to control the proper functioning of photocells before any operation of the motor is made. The security of the system is therefore higher in case the photo-device breaks down (for example, if the relay of exit is stuck) or there is a undesired short circuit on the input of the photocells. The control board indicates a possible fault by flashing only once when any key is pressed and also by not moving at all. This check is made after the control board receives a command to move, but before the control board itself gives power to the motor.

### Edge Inv.

Allows to set if, once the safety edge alarms itself, the gate must stop or it must stop and then reverse (applies only in the phase of closing)

### Edge Test

Functional test of the safety edge. Connect the safety edge as shown in the instructions by using the photocell test's clamp.

### Pre-flashing

This function commands a blinking BEFORE each movement in order to indicate the imminent movement itself.

### Zone light

There is the possibility to use the auxiliary output as a courtesy light or as a light zone (always lit-on as long as the gate is open)

### Auxiliary light timeout

There is the possibility to set the delay of switching-off of the auxiliary light after the automation stops

### Clock function

Input **OPEN** becomes input **clock** in case it is possible to connect a timer for the programmed opening of the automation. The contact is understood as a command to opening and to stay open as long as this status stays closed. When the contact is opened, then the unit reset its normal functioning, waiting for a command given by the user (if the automatic closing is required, then it must be enabled from the menu).

### Water hammer in opening

If the automation is equipped with an electronic lock, then it is advisable that, when the gate is closed, the motor shortly operates in closing before it starts the opening phase (water hammer). This function allows to unlock the electronic lock in any case, even when the weather conditions are very bad (for example in case of ice). The activation of this function enables also the electronic lock's output.

### Encoder

If the motor is equipped with a suitable encoder, then it is possible to enable the functionalities of the encoder. In such way the control board does not work any longer "by time" but "with encoder" instead. It is possible to detect the possible blocking of the motor.

### Sensor level

If it is enabled, it allows to modify the intervention sensitivity of the "stop motor" sensor. Decrease the value that is set in order to have higher sensitivity. If the sensitivity is too high and the sensor operates without any apparent reason, then increase the value.

### Sensor inversion

Allows to define the reaction of the gate in case the "stop motor" sensor applies. If the reversing is not activated, then the gate stops and waits for a new command. If the reversing is activated, then the gate reverses shortly in case the sensor applies during the opening; it open completely in case the sensor applies during the closing phase of the gate.

## **9 RESET of the control board (Menu C - Reset)**

Reset of the unit according to the display indications; this reset the control board to its factory settings  
WARNING: all programming and personal settings must be repeated after the reset of the control board!

## **10 Backlighting of the display (Menu C - Display light)**

Enter **MENU C** and follow the instructions shown on the display in order to enable/disable the backlighting of the display itself. The control board operates the function Energy saving which automatically switches off the display after the unit is inactive since some minutes. The backlighting is automatically reactivated (if this function is enabled) when the user operates on the control board.

## **11 Housing for radio receiver**

The unit disposes of a molex connector to house an ALLMATIC radio receiver. The first channel of the receiver is associated to the wired command **S.S.**, whereas the second radio-channel (if it is present) is associated to wired command **PED**. Follow the instructions of the receiver itself for learning the transmitters.

## **12 Auxiliary output (this output is available only with the additional card R1)**

The functioning of the additional card depends on the setting of the parameter "Brake":

*Parameter "Brake" OFF-1:* A normally open contact is available on the output for the activation of the electronic lock. The electronic lock can be activated by previously enabling the Water Hammer in opening (parameter Water Hammer OP).

*Parameter "Brake" 2-3:* A contact is available on the output for the activation of an external brake.

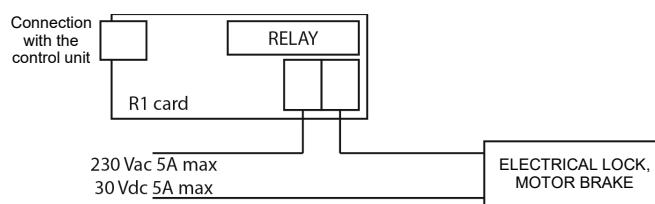

## 9 Tips for a successful installation

### 9.1 High speed movements

PROBLEM	SOLUTION
<ul style="list-style-type: none"> <li>The motor stops for the effort during the movements</li> <li>It is easy to stop the automation during the movements counteracting the movement</li> <li>The gate moves slowly despite having set an high speed</li> </ul>	<ul style="list-style-type: none"> <li>Raise the torque supplied to the motor until problem is solved <i>High Torque OP, High Torque OP</i></li> <li>Lower the speed of the motor until problem is solved <i>High Speed OP, High Speed CL</i></li> </ul>
<ul style="list-style-type: none"> <li>The motor stops and the control unit shows FAULT on the display or 10 seconds of fast blinking</li> </ul>	<ul style="list-style-type: none"> <li>Lower the torque supplied to the motor until problem is solved <i>High Torque OP, High Torque OP</i></li> <li>Lower the speed of the motor until problem is solved <i>High Speed OP, High Speed CL</i></li> </ul>

### 9.1 Low speed movements (slowing down)

PROBLEM	SOLUTION
<ul style="list-style-type: none"> <li>The motor stops for the effort during the movements</li> <li>It is easy to stop the automation during the movements counteracting the movement</li> <li>The gate moves slowly despite having set an high speed</li> </ul>	<ul style="list-style-type: none"> <li>Raise the torque supplied to the motor until problem is solved <i>Low Torque OP, Low Torque CL</i></li> <li>Lower the speed of the motor until problem is solved <i>Low Speed OP, Low Speed CL</i></li> </ul>

### 9.3 Correct working

The correct setting of parameter is when you are not able to stop the automation when trying counteracting the movement.

**The use of safety devices is absolutely necessary to ensure the safety of the automation.**

## WARNING AND ADVICES

Avoid putting the connection cables of buttons, security devices and inputs close to those of the power supply of the control unit and of the motor. Some parts of the control unit are subject to dangerous voltage. The control unit must be installed and programmed only by qualified professionals. Always use a device that ensures the disconnection of all poles of the control unit's power supply .

This device can be a switch (connected directly to the power supply terminals) with a contact's minimum distance of 3 mm for each pole, or it can be a device connected to the power network.

For connecting the card and the motors we recommend to use cables with double isolation as in compliance to the laws in force; the minimum cross section of the single conductor must not be less than 1,5 mm<sup>2</sup> and not more than 2.5mm<sup>2</sup>.

### TECHNICAL FEATURES - CT INVERTER AM

Power supply	230 Vac +15%, -15% ; 50Hz
Photocells power supply	24 Vdc 3W MAX
Accessories power supply	24Vac 3W MAX
Motor output	230Vac 1,5KW (current limited to 10A) MAX $\cos\Phi > 0.8$
Flashing light output	230 Vac 60W MAX for fixed light, without self-blinking.
Courtesy light output	230Vac 100W MAX
Auxiliary output (only with card R1). Clean contact output NOT supplied.	24Vac 0.5A MAX (12W MAX)



ALLMATIC S.r.l  
 32020 Lentiai - Belluno - Italy  
 Via dell'Artigiano, n°1 - Z.A.  
 Tel. 0437 751175 - 751163 r.a. Fax 0437 751065  
<http://www.allmatic.com> - E-mail: [info@allmatic.com](mailto:info@allmatic.com)

**GUARANTEE** - In compliance with legislation, the manufacturer's guarantee is valid from the date stamped on the product and is restricted to the repair or free replacement of the parts accepted by the manufacturer as being defective due to poor quality materials or manufacturing defects. The guarantee does not cover damage or defects caused by external agents, faulty maintenance, overloading, natural wear and tear, choice of incorrect product, assembly errors, or any other cause not imputable to the manufacturer. Products that have been misused will not be guaranteed or repaired. Printed specifications are only indicative. The manufacturer does not accept any responsibility for range reductions or malfunctions caused by environmental interference. The manufacturer's responsibility for damage caused to persons resulting from accidents of any nature caused by our defective products, are only those responsibilities that come under Italian law.