



PROXIMA M Control unit

Control unit for one motor roller shutters



ATTENTION: DO NOT INSTALL THE CONTROL UNIT BEFORE READING THE INSTRUCTIONS!



1. Introduction.

The PROXIMA W control unit is suitable to operate roller shutters and sunshades. This device houses a radio receiver for remote controlling through transmitters of the B.RO series (Fig. 1) and CLARUS series (Fig. 2). The control unit has been realized with very small sizes which allow to install it inside casing boxes type 503 (those of the normal "light point"), or also inside the boxes of the rolling shutters near to the motor. In order to simplify the installation, the power supply is 230 Vac and through three cables it is possible to connect motors with power up to 350W with internal limit switches. It is furthermore possible to connect to the control units two push-buttons for the opening and closing function.

2. Configuration.

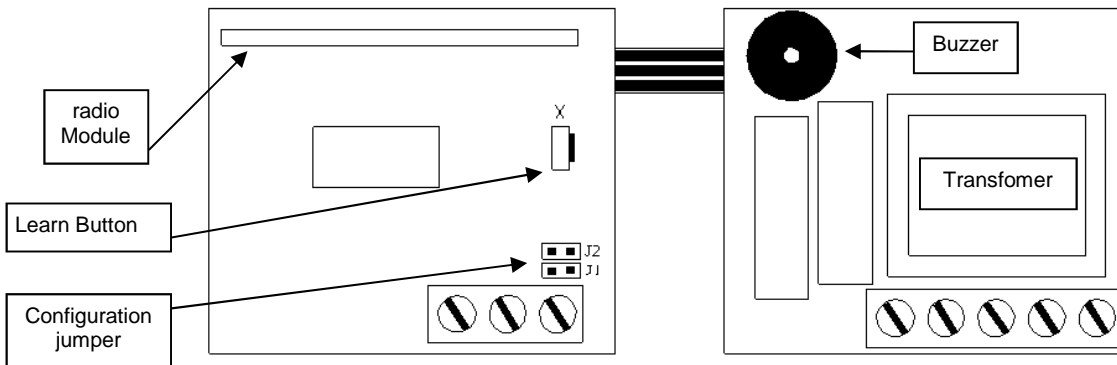
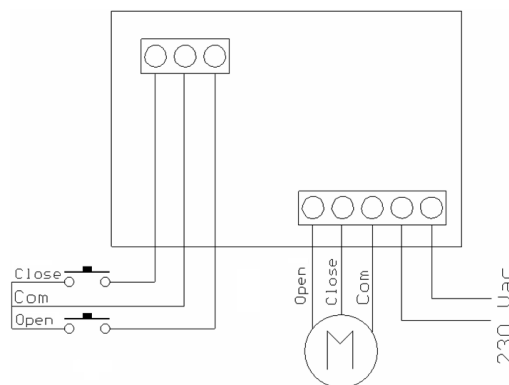

Fig.1 Tx series B.ro



Fig.2 Tx series CLARUS

3. Electrical connections.



4. Learning operations

4.1 Learning of the first transmitter

When the system is supplied with power, the control unit enters automatically the learning mode, waiting for the command signal of a transmitter. When the button of a transmitter is pressed, the control unit memorizes the channel buttons and exits the learning mode. At the next start the control unit emits two beeps (by means of the buzzer, if present on the card), indicating that at least one channel of a transmitter has been memorized.

4.2 Learning of next transmitters by means of the LEARN button



LEARNING:

- 1) Press the LEARN button on the control unit. The unit emits a sequence of beeps (by means of the buzzer, if present on the card).
- 2) Press the "a" or "a1" button of the transmitter. The control unit memorizes automatically also the "b" or "b1" button and the "c" button for the CLARUS series ("a" or "a1" as the "open" button, "b" or "b1" as the "close" button and "c" as the "stop" button). The memorization of the channel is indicated (through the buzzer, if present on the card) by two long beeps if the channel had not been previously learnt and one beep if it had been previously learnt. When channel is memorized, the control unit goes back to the normal operation mode. If no signal is transmitted within ten seconds, the control unit exits automatically the learning mode.

4.3 Learning of next transmitters by means of a previously learnt transmitter

1) **Opening memory:** To open memory from the transmitter, please refer to the user's guide of the transmitter itself. When memory of the control unit is open, this emits a sequence of beeps (through the buzzer, if present on the card) to indicate that it is entering the learning mode.

2) Press the "a" or "a1" button of the transmitter. The control unit memorizes automatically also the "b" or "b1" button and the "c" button for the CLARUS series ("a" or "a1" as the "open" button, "b" or "b1" as the "close" button and "c" as the "stop" button). The memorization of the channel is indicated (through the buzzer, if present on the card) by two long beeps if the channel had not been previously learnt and one beep if it had been previously learnt. When channel is memorized, the control unit goes back to the normal operation mode. If no signal is transmitted within ten seconds, the control unit exits automatically the learning mode.

4.4 Deleting a transmitter from the memory of a control unit

PRESS the "e" hidden key



PRESS the "e" hidden key + "a"



DELETING a transmitter of B.RO series:

- 1) Press the "e" hidden key in the transmitter. The control unit emits a sequence of beeps (through the buzzer, if present on the card) or flashings. This operation is equivalent to pressing the LEARN button, but without need of physically opening the control unit.
- 2) Press at the same time for a few seconds the hidden key and a key of the transmitter that must be deleted (e.g. "e" and "a" or "e" and "a1"). Deleting is signaled by means of 4 long beeps (through the buzzer, if present on the card). After this, the control unit goes back to the normal operation mode.

DELETING a transmitter of CLARUS series:

In order to delete a single channel or the complete transmitter, it is necessary to enter the internal menu of the transmitter itself. To carry on this operation, please refer to the user's guide of the transmitter.



Warning: Do not carry on this procedure if more than one control unit is working, because the opening of memory would take place for all devices where a channel has been memorized. Cut power supply for all control units not involved in the operation.

4.5 Total memory reset of a control unit

- 1) Cut power supply of the control unit
- 2) Keeping the LEARN button pressed, give power back to the control unit. The unit emits a sequence of continuous beeps (through the buzzer, if present on the card). When signal stops, reset procedure is completed and it is possible to release the LEARN button.

After this operation the control unit will emit a sequence of beeps (through the buzzer, if present on the card) first fast and then slow, to indicate the empty memory. The control unit will automatically enter the learning mode, waiting for a signal from a transmitter.

5. Advanced configuration: setting of jumpers (if present)

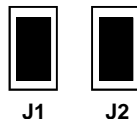
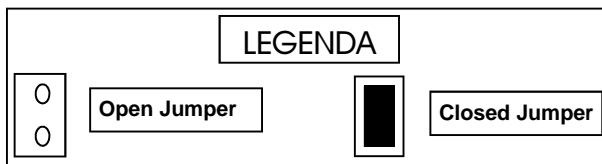

Transmitter Pushbuttons

Pressing shortly the open / close buttons activates the opening / closing for a short movement (snap). This allows the setting of Venetian blinds.

Pressing for a longer time leads to a complete opening/closing of the shutter. In order to stop the automation in the required position, press the STOP button or the button operating the movement in the opposite direction.

Wall pushbuttons connected by cable:

The operation is analogous to that for the transmitter pushbuttons concerning the snap progress, useful for Venetian blinds. An extended pressing of the OPEN button activates opening. A further pressing of the same button stops the opening. Pressing the CLOSE button activates the inversion of the run direction (closing). Operation is specular for the other button.

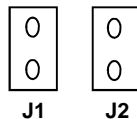

Receiving of the transmitters

Disabled

Wall pushbuttons connected by cable:

Dead man operation, meaning that the roller shutter goes up/down while the buttons are kept pressed. Releasing them the roller shutter stops.

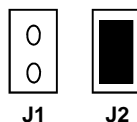

Transmitter Pushbuttons

Pressing the open/close button the roller shutter opens or closes completely. A second pressing of the same button does not stop the movement. In order to stop it press the STOP button or the button for the movement in the opposite direction.

Wall pushbuttons connected by cable:

Operation is analogous to transmitter pushbuttons.

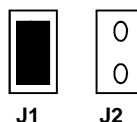

Transmitter Pushbuttons

The operation is step by step with 1 button: the first pressing of the OPEN button starts the opening, the second pressing stops the roller shutter, the third closes.

Please Note: In this operation mode the control unit is controlled by a single transmitter button, precisely the "a" button. The "b" button will not have any effect and the "c" button keeps the STOP function.

Wall pushbuttons connected by cable:

The operation is step by step with 2 buttons: the first pressing of the OPEN button starts the opening, the second pressing stops it and the third restarts it. The same happens for closing, by means of the related button.

GUARANTEE - In compliance with legislation, the manufacturer's guarantee is valid from the date stamped on the product and is restricted to the repair or free replacement of the parts accepted by the manufacturer as being defective due to poor quality materials or manufacturing defects. The guarantee does not cover damage or defects caused by external agents, faulty maintenance, overloading, natural wear and tear, choice of incorrect product, assembly errors, or any other cause not imputable to the manufacturer. Products that have been misused will not be guaranteed or repaired. Printed specifications are only indicative. The manufacturer does not accept any responsibility for range reductions or malfunctions caused by environmental interference. The manufacturer's responsibility for damage caused to persons resulting from accidents of any nature caused by our defective products, are only those responsibilities that come under Italian law.